

PIG MOTION AND DYNAMICS IN COMPLEX GAS NETWORKS

Dr Aidan O'Donoghue, Pipeline Research Limited, Glasgow

A model to examine pigging and inspection of gas networks with multiple pipelines, connections and customers is presented in this paper. A case study of a typical gas system with multiple lines, connections and off-takes is presented to demonstrate the use of such a model for planning and executing real life operations. A gas flow rate is provided into the network to the various users of the network or grid. Each customer has a requirement for both a minimum pressure and a minimum flow that cannot be disrupted without agreement or penalty to the operating company. Additionally, inspection or ILI tools must be run within certain velocity constraints to allow reliable data to be achieved. Due to the complexity of the system, there is a risk that the pig could stall in the line as flow is diverted as a result of the pigs own differential pressure. Manipulation of valves and flows must be planned and performed carefully so as not to disrupt the demands of the various customers in the network. Excessive pressure drop across closed valves is undesirable if they are to be opened during the operation. Pigging the system is onerous due to the need to balance the requirements of the pigs and the demands of the customers. The pig run time or expected arrival time with transient events such as valves opening, changes in flows, disruption to customers and other transient events is calculated. The paper presents the model and its use to optimise pigging programs in gas networks.

Introduction

Pigging of a complex gas network can result in disruption to the various customers online due to the need to control and divert flows, control pressures, and manipulate valves. The result may be downtime for the system and possible penalties for the operator. A compressible gas flow model (known as PIGLAB) with pigging is used to examine flows, pressures and pigging in such complex gas networks. This is a transient model where boundary conditions can be altered at any stage with a corresponding change to the pig motion. The pig motion is also transient by nature and changes with the elevation profile of the pipeline and the friction it encounters in the pipe.

A case study is presented to demonstrate the model and its application in minimising disruption while pigging. The case study presented considers a gas terminal exporting gas across a 520 km mountainous terrain via a 24-inch line and a 26-inch line. Two customers on the route each take 0.5 mmscmd (million standard cubic meters per day) gas flow as sales quality gas. The first off-take is via a 12-inch 100 km line and the second is situated adjacent to the pipeline at kilometre post, KP 480. The flow at the end of the line, for onward transportation to another country is 4.5 mmscmd. Inlet pressure is maintained at 80 barg. The scenario is shown in Figure 1 is fictitious but is typical of actual analyses performed using this model.

This describes the initial status of the line. There are three stages of development of the model as discussed in this paper: -

1. The original line as shown in Figure 1 and 2 with a total export flow of 5.5 mmscmd and 80 bars export pressure at the gas terminal (described above);
2. An expansion to the system with the introduction of a parallel 24-inch pipeline and compressor station to allow the system capacity to be taken up to 10 mmscmd with additional customers;
3. Following issues with the line pipe in the original 24-inch section, a 10 km section of 20-inch pipe was used to repair the line.

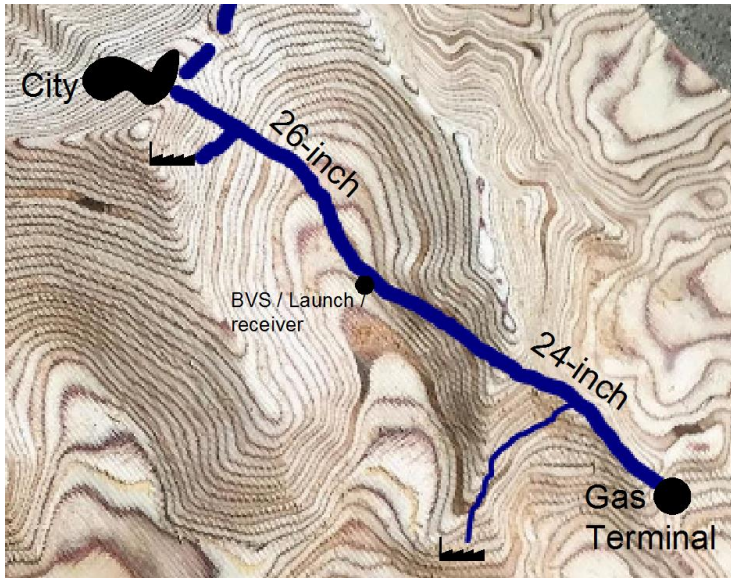

Figure 1 – 520 km 24-inch to 26-inch gas export route from the Gas Terminal to onward export, showing customers and elevation profile.

The analysis examines the deployment of pigs in each section of the line with altering or transient conditions (Increasing and reducing flow, changing pressures for example). Several different pig types can be deployed – cleaning pigs with and without bypass and MFL tools with and without speed control. The model shows how downtime can be reduced and the effect on the customers minimised.

Model Description

A transient pigging simulation program (PIGLAB) has been set up to model the gas flows in the pipeline along with the motion of various types of pig. The model for the original line (24-inch and 26-inch) is shown below in Figure 2.

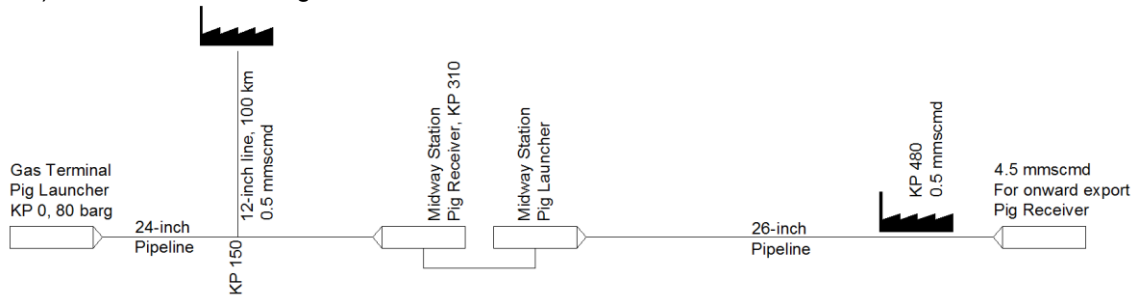

Figure 2 – Schematic of the pipeline showing the launcher and receiver on the 24-inch section and the 26-inch section. The inlet condition (fixed) is 80 barg. The two customers along the route each take 0.5 mmSCMD. The outlet flow at the end of the 26-inch line is 4.5 mmSCMD planned or steady state.

As noted in Figure 1, the terrain is mountainous. The following graph shows the overall terrain from launcher at the Gas Terminal to the outlet at the 26-inch receiver.

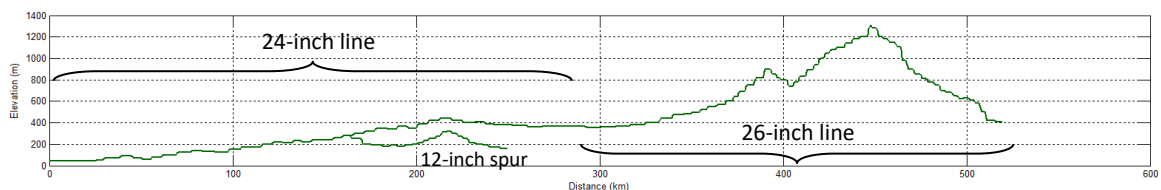

Figure 3 – Elevation of the 24-inch and the 26-inch lines and the 12-inch spur line. The line elevation is an input into the model.

The model allows several lines of various sizes to be linked together, gas flows and pressure boundaries to be set up and then the various lines can be pigged. It is possible to include the following features in the lines: -

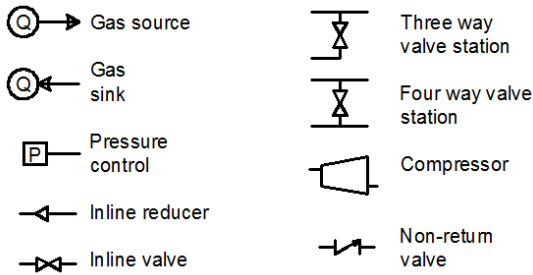

Figure 4 – Component palette available in PIGLAB used to model a given pipeline system.

Different pipeline sizes and section lengths can be used to connect to these components to make up the full system for analysis.

Different pig types can be entered into the model. It is possible to have non-bypass pigs, pigs with fixed bypass and pigs with Active Bypass Control, ABC (with control valve to control the speed of the pig). The friction of the pig in the pipeline is inputted as a data file using differential pressure against location in the line.

The model solves the gas continuity and gas momentum equations throughout the system. If there is a pig in the line, then it provides the pressure immediately upstream and downstream of the pig. This allows the pig velocity to be determined: -

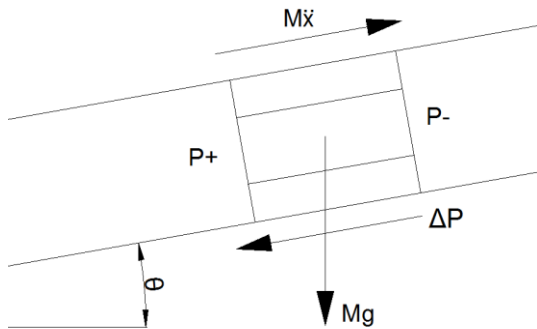

Figure 5 – Force balance on the pig to determine its dynamic behaviour in the pipeline. The pig DP or Differential Pressure can change with location as the pig negotiates bends and various features. The pig DP is accepted as input into the model.

This results in the following: -

$$M \ddot{x} = (P^+ - P^- - \Delta P_{pig} - Mg \cos \theta) A$$

Where: -

- M , pig and pig train mass;
- \ddot{x} , acceleration;
- P^+ , Pressure behind the pig;
- P^- , Pressure in front of the pig;
- θ , Angle of pipeline;
- ΔP , Differential pressure required to drive the pig (entered as a look-up file into the program).

Pig velocity is then determined as a function of time and location. The boundary conditions (flows and pressures can be varied during the analysis to simulate shutdowns, turndowns and start-ups. The various line components such as valves and compressors can be altered (valves opened and shut and compressors switched on or offline). The result is a model that can be used to simulate pigging under various operating scenarios.

Simulation 1: Original Pipeline

To begin with, the line is relatively simple with pressure control at the Gas Terminal and the following outlet flows: -

- 0.5 mmscmd at 12-inch off-take;
- 0.5 mmscmd at customer at KP 480;
- 4.5 mmscmd at the end of the line.

Pressure is held at 80 bars at the inlet to the line. There is a requirement that pressure at the outlet of the line does not drop below 40 bars. The first task is to run the model to steady state. This is performed by letting the flows and pressures along the length of the line reach a steady value. This is shown for the original pipeline in Figure 6: -

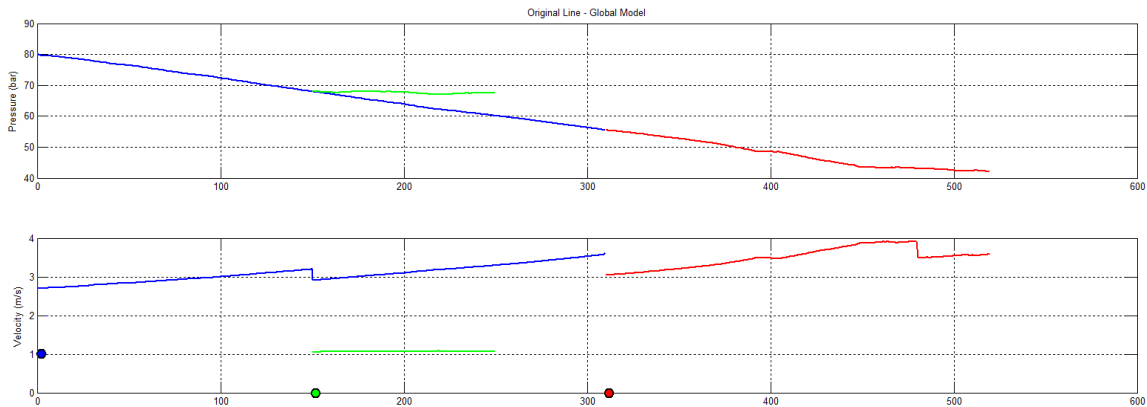

Figure 6 – Steady state pressure and flow velocity in the line along the length of the three pipelines (24-inch in blue, 26-inch in red and 12-inch in green). The pigs, in corresponding blue, red and green are shown ready to launch.

Pig 1 (Line 1, 24-inch, blue) is launched first. There are various restrictions along the length of the line, which result in an unsteady motion for the pig. These correspond to various river and road crossings where a thicker wall pipe is used resulting in a higher friction. The pig slows down momentarily at these locations and accelerates out at the end of the crossing.

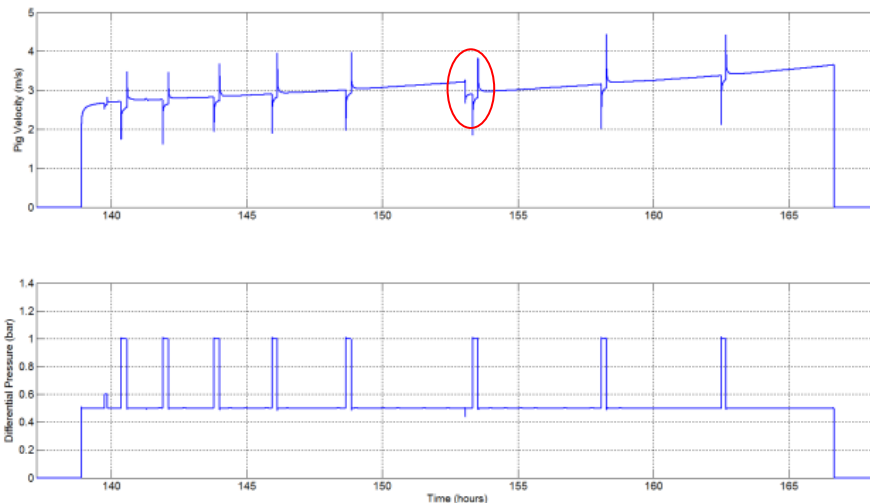

Figure 7 – Pig 1 velocity response in top graph. The pig differential pressure is shown along the bottom graph against time. An increase in DP tends to slow the pig while a reduction in DP causes an acceleration or velocity excursion. It is possible to perform sensitivities on the levels of friction or DP in each section.

The reduction in pig velocity at the 12-inch off-take is also noted – circled in red. There is little further to report on the velocity profiles as the pig merely runs from launcher to receiver. One point of interest for the 12-inch line is the delay in launching the pig, since pressure needs to drop downstream and this causes a delay.

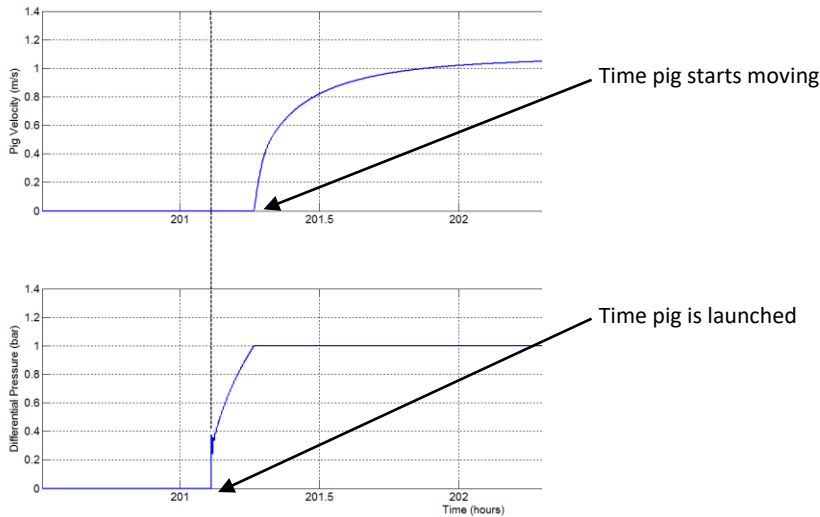

Figure 8 – Launch time is shown with the black dashed line. The pig does not move however for circa 10 minutes as it waits for the differential pressure to drop in front of the pig. Upstream (24-inch) pressure remains reasonably constant as it is required to wait for the 100 km line to reduce in pressure by one bar.

Knowledge of this type of phenomena can avoid over reaction as it could be mis-interpreted that there is a problem with the pig, the launcher or the launching condition.

Finally, for this initial analysis, the PIGLAB model can be used to predict the arrival or ETA (Expected Time of Arrival) of the pig. The following example shows how a variation (reduction in) outlet flow is mirrored in the expected arrival time for the pig.

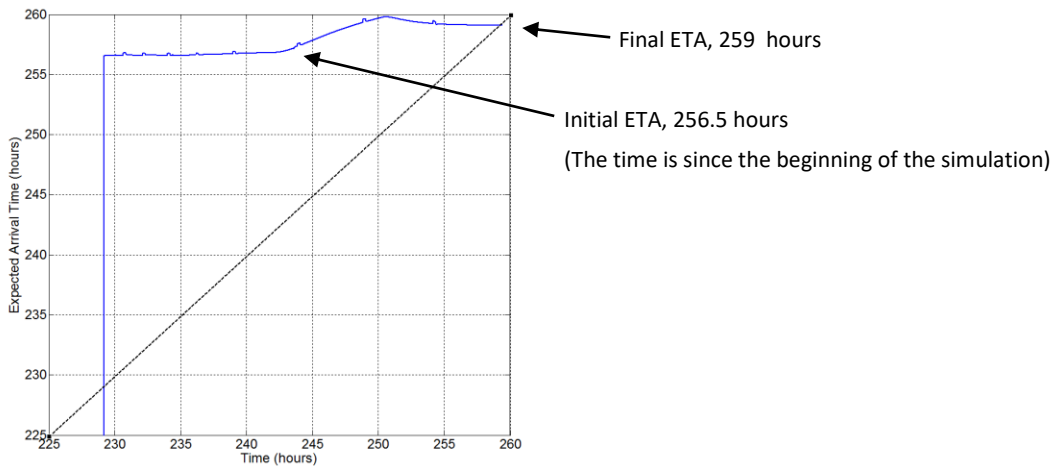

Figure 9 – Expected arrival time (hours) against actual time. Initially after launch the pig is set to arrive at 256.5 hours (Launched at 229 hours). Following a process upset (reduction in outlet flow) at the end of the line and eventual recovery of this flow; the new arrival time is determined and plotted at 259 hours.

Many different transient events can be programmed to occur and the effect on the pig arrival can be determined.

Simulation 2: After Pipeline Extension

In order to increase the capacity of the pipeline to 12 mmscmd, the following steps were undertaken: -

- A parallel 24-inch pipeline was installed using two three-way valve components to link it to the old 24-inch line and 26-inch line;
- A compressor station was installed in the 26-inch line at an available slot using a compressor component.

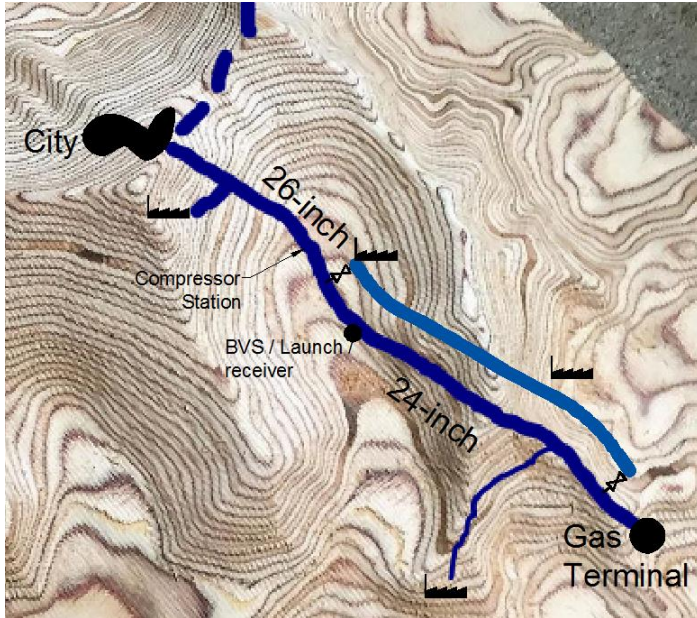

Figure 10 – Pipeline after the extension project showing the parallel 24-inch pipeline and the compressor station.

Two new customers were brought on stream as shown and all customers were upgraded to 1 mmscmd each.

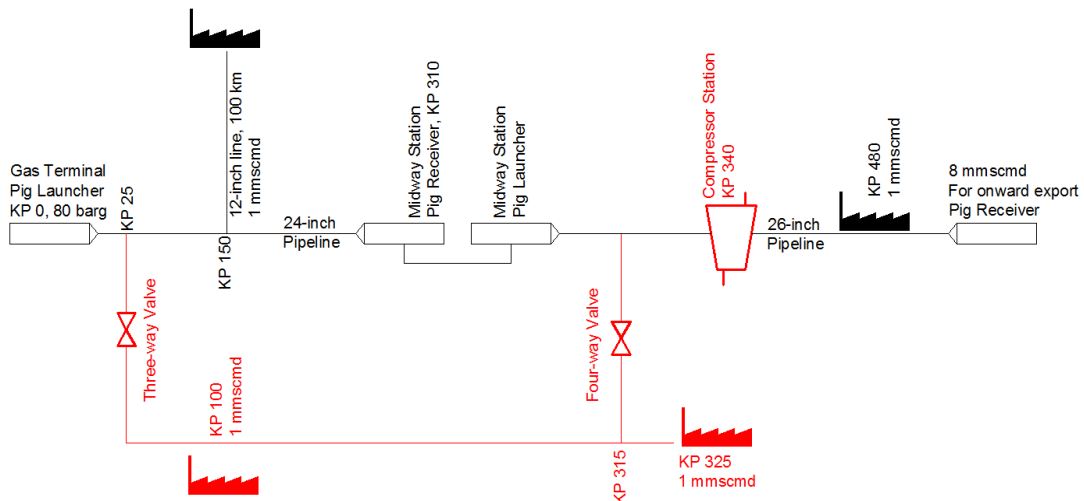

Figure 11 – Extended pipeline with 90 bar inlet pressure, parallel 24-inch line with new customers, compressor station at KP 340 resulting in increased capacity of 12 mmscmd. The changes are shown in red.

The outlet flow condition dictates that the pressure must not drop below 40 bars as before. It is also a requirement that the inlet pressure to the compressor does not drop below 40 bars.

The initial stage of the analysis is to perform a steady state analysis of the line as before. The output from this is shown in Figure 12. The extended pipeline provides more flow as required but when it comes to pigging, there are new challenges.

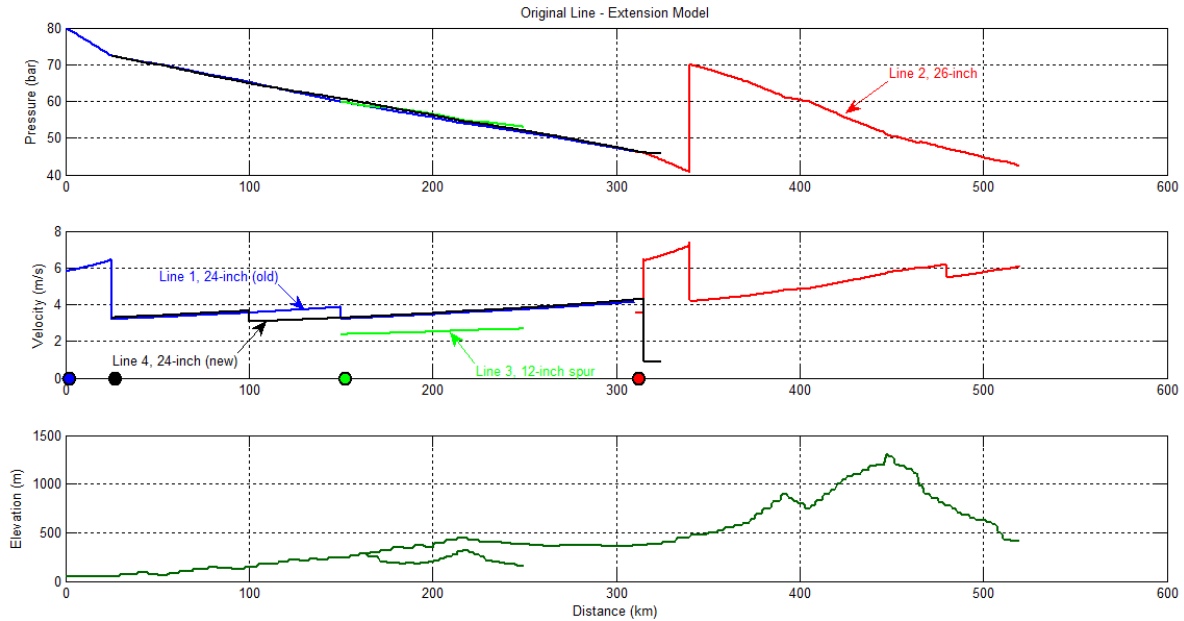
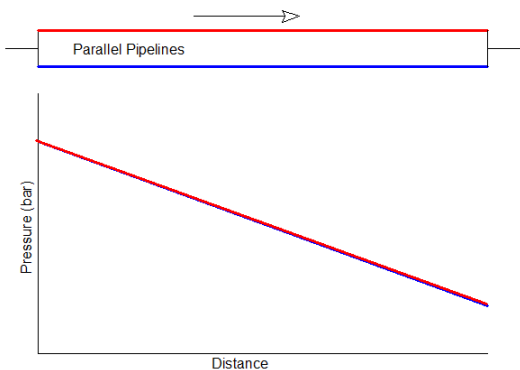

Figure 12 – Steady State output from extended model with new 24-inch parallel line (in black).

- The flow velocity is high at some locations for pigging (especially inspection pigging). It is necessary to adjust this prior to inspection or run pigs with Automatic Bypass Control (ABC);
- In order to pig the 26-inch line, the compressor must be turned off. This means that flow must be reduced or the flow will choke and pressures at the outlet will drop below 40 bar;
- Care must be taken when pigging two parallel lines, as there is a risk of flow diversion. This is explained below.

Flow diversion can occur if two parallel and connected pipelines are pigged. If the friction across the pig increases, then the flow can divert to the parallel line to compensate. The result is that the pig slows down and in some cases; this can result in zero flow and a stalled pig. This is of particular concern if the flow has already been reduced for one reason or another, an outage for instance. The issue is demonstrated in the following graphic: -

(a) No pig in the line. Same pressure drop across both lines as they are connected at start and finish. In this case, there is the same flow in both lines (same diameter and length).



(b) Pig in blue line. If the pig DP is large compared to the line pressure drop and since flow is proportional to the pressure gradient, flow reduces in the blue line, diverts to the red line and there is a risk of the pig stalling.

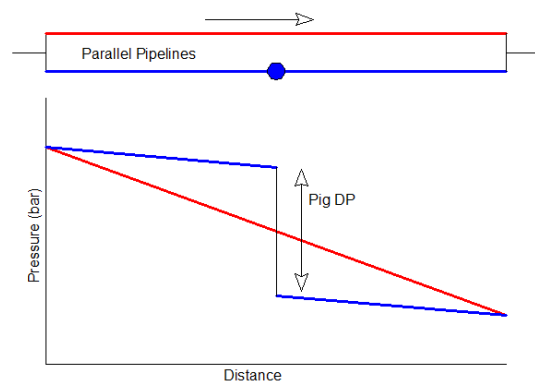

Figure 13 – Why there is a risk of stalling when pigs are run in parallel pipelines.

In order to pig the new pipeline system, the following plan is put in place: -

1. Pipeline at steady state;
2. Run cleaning pig through Line 1;
3. Run an ABC (speed control) MFL pig through Line 1 or reduce flow and deploy MFL tool. Increase flow after the tool passes KP 25 (three way valve to the new line) – note predicted ETA;
4. Reduce flow and switch off compressor (a pig cannot be deployed through the compressor);
5. Launch pig into Line 2 and examine risk of flow diversion;
6. Launch pig into line 3 (no change from previous);
7. Launch pig in new line 4. Risk of low pressure at outlet to customer.

There are a number of potential disruptions to the customers and the down time must be calculated. This can be built into the contracts with these customers but it then places time pressure on pigging operations to be done correctly and without issue to avoid penalties.

A cleaning pig can be deployed at full flow conditions through line 1 despite the high velocity for the first 25 km: -

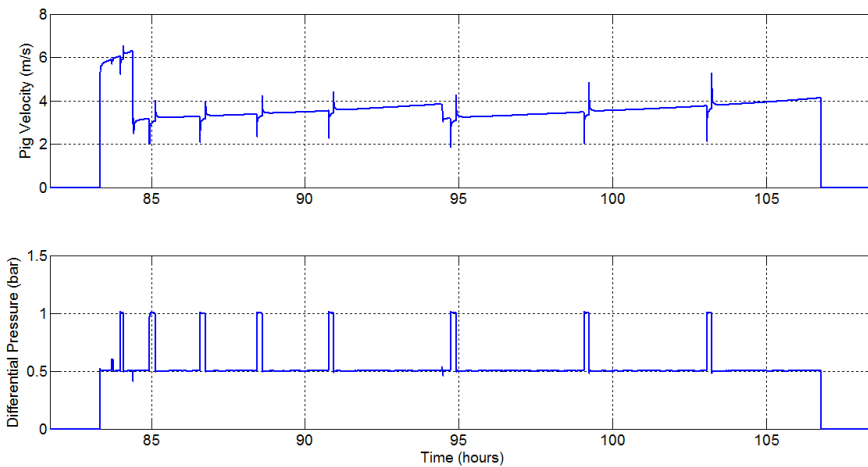

Figure 14 – PIGLAB output for the cleaning pig deployed at full flow with peak velocity of 6.5 m/s.

Despite the high velocity in the first 25 km of the line, the cleaning pig can be deployed with no change in conditions. On the other hand, some steps must be taken during inspection with MFL. Ideally, a speed control type pig using a bypass control valve to maintain the tool speed close to the set condition should be used. The output for this is shown below.

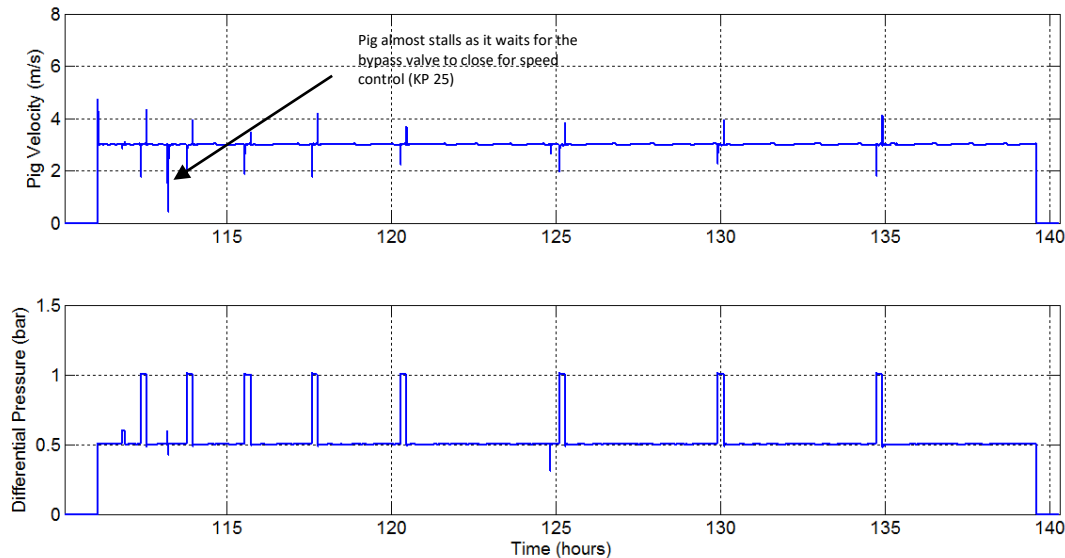

Figure 15 – Deployment of MFL tool with ABC (Automatic Bypass Control) using a bypass control valve. The aim is to maintain pig velocity between 1 and 4 m/s typically. Lag in the control system means that there are still velocity fluctuations.

A 3 m/s set position is chosen for the run. A simple feedback control loop with lag is used to model the bypass valve with input from the odometer wheels. The tool speed is maintained close to 3 m/s for the majority of the run but there are still some excursions at the junction with the new line and at tight spots in the line. The reason for this is that the control valve on the pig takes time to react to the changes in pig speed. For example, at the junction with the new line at KP 25, the control valve has to close suddenly to account for the reduced flow. This does not happen immediately and the pig velocity drops.

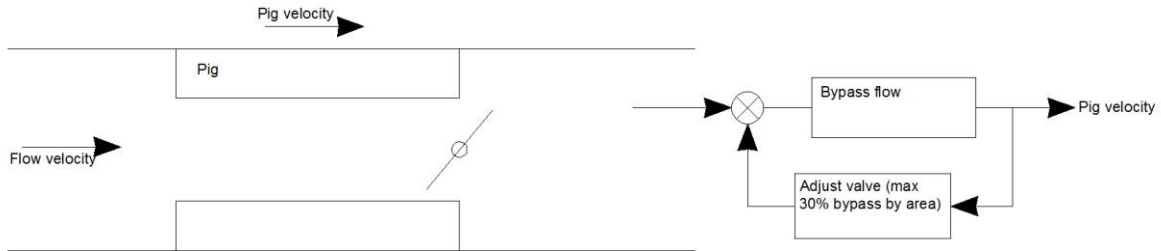

Figure 16 – Bypass control using valve linked to pig odometer system to adjust the pig velocity to a set point.

Bypass control might not always be available, especially at smaller diameters or depending on the selection of ILI vendor. In such a case, the flow in the line must be reduced and this could cause difficulties for the customers along the line if unplanned. The aim is to have the minimum length of time at low flow and to be able to inform the users of the expected length of time for the upset conditions. Flow is reduced at the system outlet such that the velocity in the first 25 km is less than 4 m/s. Once the pig is known to have passed this point, the flow can be increased: -

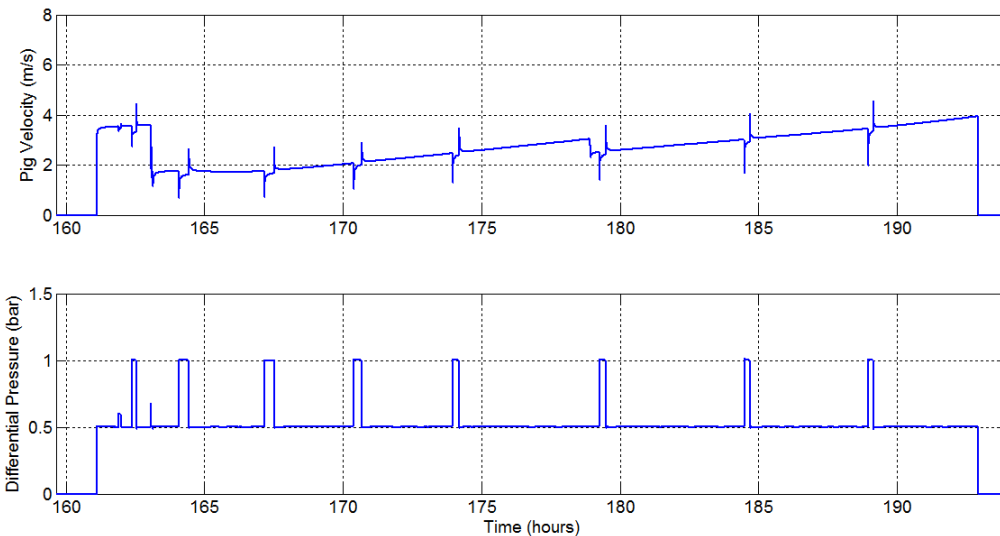

Figure 17 – Reduced flow for 24 hours while the system adjusts to allow pigging to take place. Note the time taken for flow to recover. This is due to the compressibility of the gas.

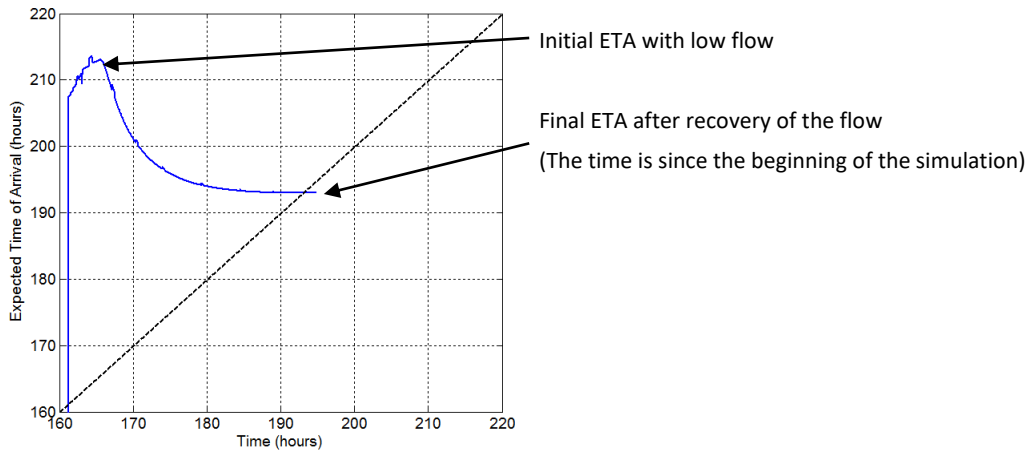

Figure 18 – Expected arrival time at the receiver is reduced as the flow is increased. The slow recovery of the arrival time is noted.

Despite increasing the flow soon after the pig passes the 25 km mark, the flow takes several hours to re-establish itself along the line. This is due to the compressible nature of the gas flow and the length of the line. What happens at one end of the line takes some hours to make an impact several hundred kilometres away. One optimisation would be to increase the flow earlier as it does not affect the pig for some hours.

A similar adjustment is required for Line 2, the 26-inch line as there is an inline compressor installed in this line. It is not possible to pig through this and it must be offline and bypassed. The flow must be reduced to avoid choking.

To demonstrate the principle of flow diversion during the pig run in line 2, a considerable obstruction is placed in the first few kilometres of the line ramping up to 5 bars pig DP. The PIGLAB model allows various what-if scenarios and sensitivities to be investigated. The pig velocity is slowed as the flow takes the path of least resistance. The graph below is a snapshot in time of a dynamically changing situation – the pig is slowing down and the flow is diverting: -

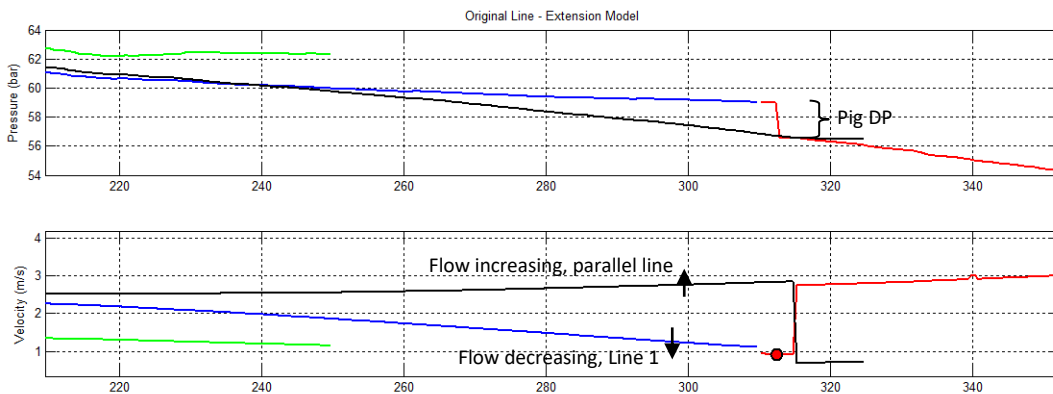

Figure 19 – Flow diversion as the red pig moves down line 2. The high differential pressure across the pig is shown in the top plot (circa 3 bar). As a result, the flow is slowed in this line to match the pig.

In an extreme case or if the pressure drop in the parallel lines was close to the maximum pressure drop across the pig, then the pig could stall as flow diverts. It is then necessary to close a valve in the system to avoid this eventuality, closing off a section of the line and potentially starving one section of line from flow. Pressures could reduce below the required 40 bar minimum.

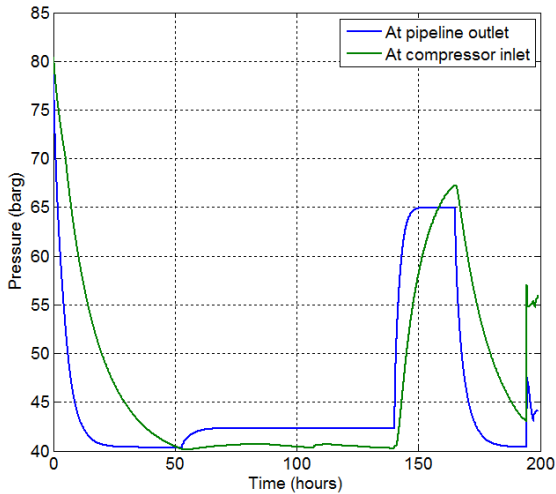

Figure 20 – Check that the pressure at key locations do not fall below the all important 40 bars limit.

Finally, for this analysis, a pig run in the new pipeline is reasonably straight forward as the steady state flow conditions are acceptable. A restriction in the last section of the line before receipt may cause a temporary low pressure at the outlet and this must be taken into account in any risk assessment. The model allows multiple scenarios to be investigated in order to select the correct flows, pressures, durations of disruption and contingencies to be put in place. Input to risk assessment or answering actions from a risk assessment is also possible and optimisation of pigging the network is achieved by running various scenarios and possibilities.

Simulation 3: After Repair of Original Line

A final analysis is performed following a repair to the original pipeline. As a result of an incident in the 24-inch section close to the receipt, a section of line was removed and replaced with a smaller diameter, available section of line. Due to difficulty sourcing the correct line size (24-inch), a section of 20-inch was installed for the last 10 km of the line to the receiver.

The effect of this is to increase the differential pressure required to get the 24-inch x 20-inch pig through the line and the pig can slow due to flow diversion. It was required to establish if any valves were required to be closed during pigging and the likely disruption to the customers.

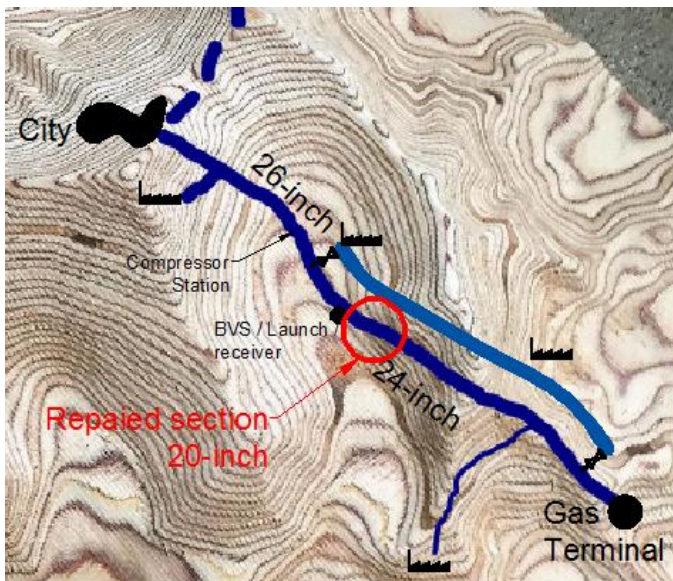

Figure 21 – Section of 24-inch line replaced by 10 km of 20-inch line following a repair.

The same setup is used but a reducer is introduced to model the reduction down to 20-inch. The result is a higher differential pressure in Line 1 that results in slowing of the pig and possible flow diversion for a prolonged period. The requirement from the analysis was to show that the line was still piggable without sufficient flow diversion that would stall the pig and an examination into how much longer pigging would take.

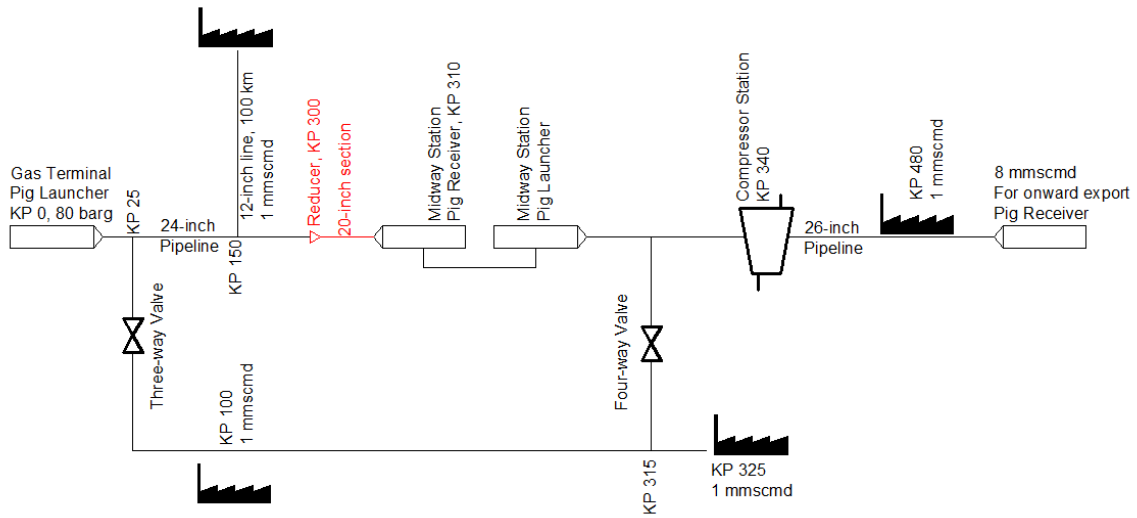

Figure 22 – System with new 20-inch replacement section in the original 24-inch pipeline. The change is shown in red.

An analysis is performed with a cleaning pig deployed in the 24-inch x 20-inch repaired pipeline. The pig is equipped with 4 x 30 mm bypass ports – included as a precaution due to some debris in the pipeline.

The pig velocity against time is shown in Figure 23. It is noted how the pig velocity drops in the 20-inch section and recovers very slowly despite the higher flow velocity due to the higher pig friction and the bypass ports.

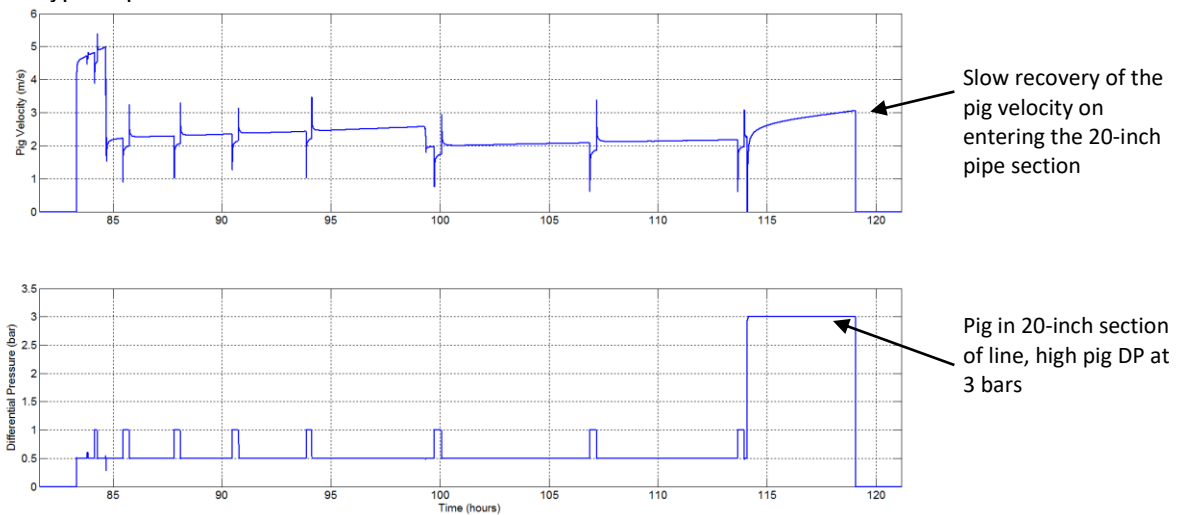

Figure 23 - Pig velocity against time with pig differential pressure shown. The pig initially stalls as it enters the 20-inch section of the line. There is then a very slow recovery of pig velocity. This is due to diversion of flow into the parallel line.

An alternative and possibly safer way of running this pig would be to reduce flow, shut the first valve at the cross over to the parallel 24-inch pipeline and divert flow as shown below.

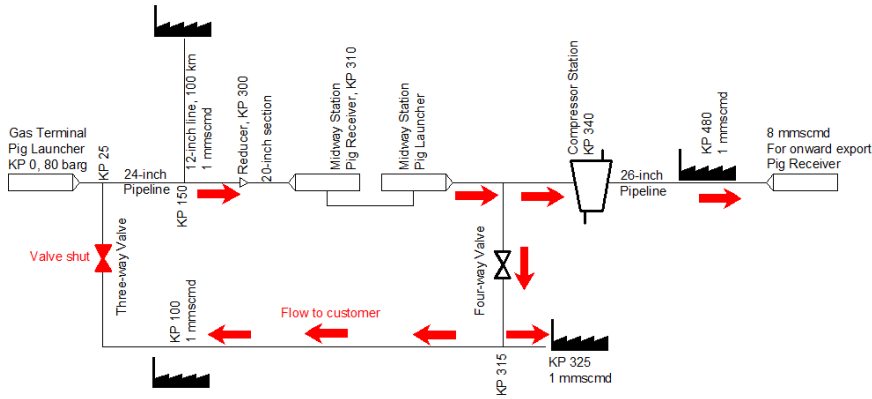

Figure 24 – Flow is reduced to avoid choking and the cross over valve to the extension or parallel line is closed at KP25. Flow diversion cannot occur when pigging the original 24-inch line. Flow can still reach the customers on the parallel line via the four-way valve.

From a pigging point of view, this is safer as flow cannot divert around the loop. The resulting flow and pressure is shown below.

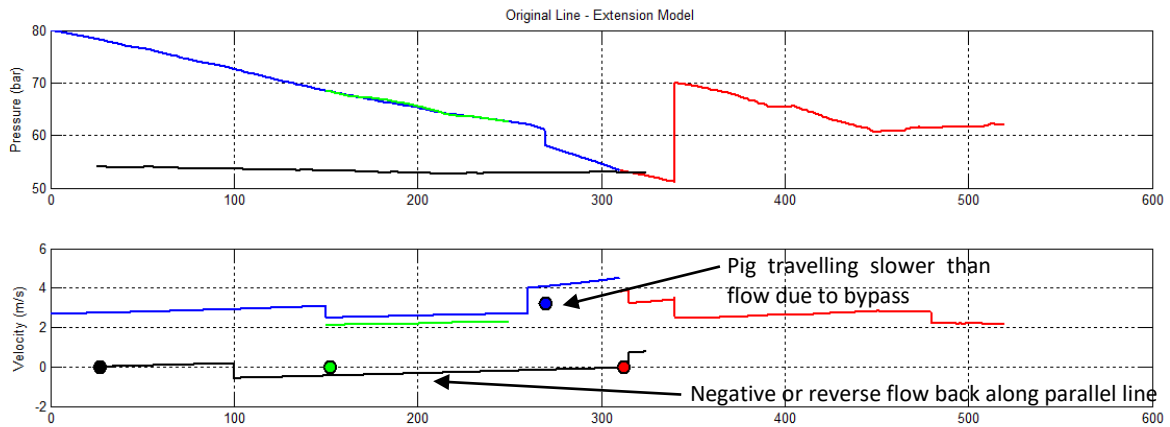

Figure 25 – Flow and pressure in the line during pigging with the cross over valve shut.

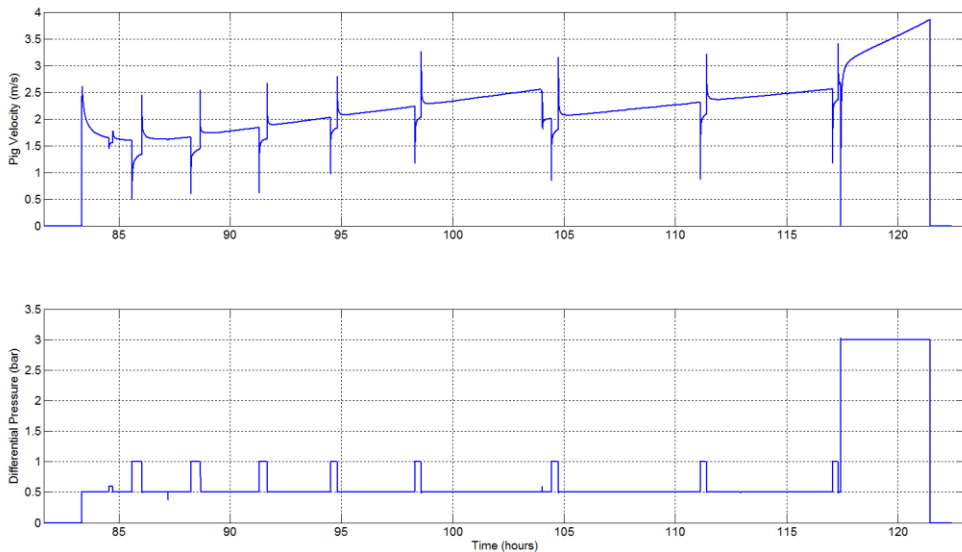

Figure 26 – Pig velocity with half flow-rate. The risk of flow diversion is higher due to the lower flow and lower line pressure drop. Since the flow is lower, one solution is that the parallel line be partially isolated to avoid flow diversion during pigging

There is one major failing with this method. Once the valve at the cross over is shut, then a very large pressure drop develops across the valve. The pressure drop reaches over 25 bar making it very difficult to open. This is not acceptable as a result. PIGLAB clearly demonstrates that this alternative would not be appropriate for this operation.

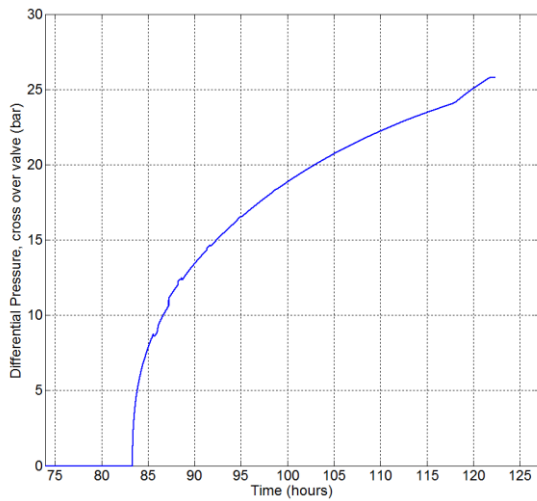

Figure 27 – Pressure drop across the various valve in the system during the last pigging operation. An excessive pressure drop is noted across the cross over valve making this method of pigging untenable.

Summary and Conclusion

A transient flow gas model PIGLAB has been set up to allow the operation of a complex gas network to be investigated in terms of transient flows, pressure and pigging dynamics.

The gas network can consist of interlinked lines with valves, compressors, gas sources and pressure control. Steady state operation of the system can be established and the effect of changing flows, opening and shutting valves, starting or stopping compressors can be examined.

For pigging analysis, the need to control the pig speed to within an acceptable band means that some disruption to the customers along the line may be necessary. The model allows this to be investigated and the conditions for optimised pig speed to be determined. Disruption can then be minimised by analysis of sensitivities.

The risk of flow diversion, coupled with bypass pigging for instance is also investigated. Pigging in a looped system may cause flow to be diverted around the pig resulting in a stalled pig. This can happen if the pig differential pressure increases for instance. To solve this, valves may need to be closed to force the pig to keep moving.

The required outcome is a reduction in the duration that the plant is running at a reduced rate and disruption to the customers along the route can be minimised. Checks can also be made to ensure that the pressure in the system does not drop below required minimum level and that pressure drops across valves are acceptable before opening.

Acknowledgements

The work to get to where the model is now has been the result of several projects with a number of operators and a considerable internal R&D effort over the years. Pipeline Research Limited would like to thank BP and Statoil primarily for the opportunity to work on real life projects requiring detailed engineering effort to optimise and control pigging and make it predictable.