

PIPELINE BLOCKAGE REMOVAL METHODS – INVASIVE OPTIONS

By: Dale Millward, STATS Group, UK

Abstract

Pipeline blockages caused by scale, wax build-up or hydrates can sometimes be removed by non-invasive techniques, such as chemical treatment or pulsed blockage removal technology. Some pipeline blockages may have been caused by normal operational pigging or more likely due to cleaning operations prior to inline inspection (ILI). Recently we have become aware of several ILI tools causing partial or complete blockage of the pipeline.

When non-invasive techniques have proved unsuccessful or unsuitable then a more invasive blockage removal intervention may be required. The less invasive method of blockage removal would be to inject and flush locally, via small bore hot taps through a dual seal, self-energised, lightweight strap clamp.

If the blockage cannot be removed by local flushing / chemical injection, then the blocked pipeline section may need to be completely removed and replaced. If a temporary bypass is installed, production can be resumed while the blockage removal operations are executed. This short presentation will explain how type approved double block and bleed hot tap installed isolation tools enable the safe removal of the blocked section while the pipeline is at operating pressure.

Animations and footage of recent subsea pipeline intervention projects will be used to highlight the applications of these techniques.

Pipeline Blockage Causes

- ❖ Gradual changes in pipeline contents (Temperature, Flowrates, Pressure, Chemistry)
- ❖ Production upsets (chemical injection)
- ❖ Operational changes – pigging frequency
- ❖ Insufficient pipeline preparation / cleaning and geometry proving for In-line-Inspection
- ❖ Overzealous progressive pigging campaigns
- ❖ Incorrect selection and application of type of pig. e.g. using a non-bypass pig for pipeline dewaxing

Blockage Composition

- ❖ Wax / asphaltenes
- ❖ Scale
- ❖ Debris
- ❖ Hydrates
- ❖ Pigs or pigged tools such as inline inspection tools becoming stuck



Figure 1. Asphaltene – Potential Pipeline Blockage [1]

Consequence of Pipeline Blockage

Reduced or total pipeline production. If the blockage cannot be removed, then the pipeline (or a section of it) need to be replaced.

Locating Pipeline Blockages

To enable blockage removal the location and extent of the blockage needs to be determined.

Pipelines blockages can be located by:

- ❖ Pressure pulsing – can detect a blockage and in some cases disassociate and remove a blockage
- ❖ Density change scanning tools / Flooded Member Detection (if the pipeline is unburied)
- ❖ Pig detectors trackers – if transponders were included in the pig that has stopped moving
- ❖ Pressurisation / depressurisation timing

Blockage Remediation

The options available to remove a blockage are highly dependent on what the blockage is comprised of; the location and extent of the blockage, pipeline length / diameter / depth / contents etc.

Blockage remediation methods

- ❖ Depressurisation can lead to hydrate dissociation
- ❖ Reversing flow and high-speed flushing
- ❖ Deploying various types of pigs. (Bypass pigs, shunt pigs, foam pigs,)
- ❖ Pressure pulsing of high frequency low amplitude pressure pulses can in some cases disassociate and remove a blockage – better suited to liquid lines, limited to approximately 8km
- ❖ Coiled tubing inserted into the pipeline can remove blockages - limited to approximately 16km
- ❖ Injecting high pressure water / diesel / chemicals to remove debris such as wax, scale sand asphaltenes
- ❖ With a fishing tool attachment could recover a stuck pig

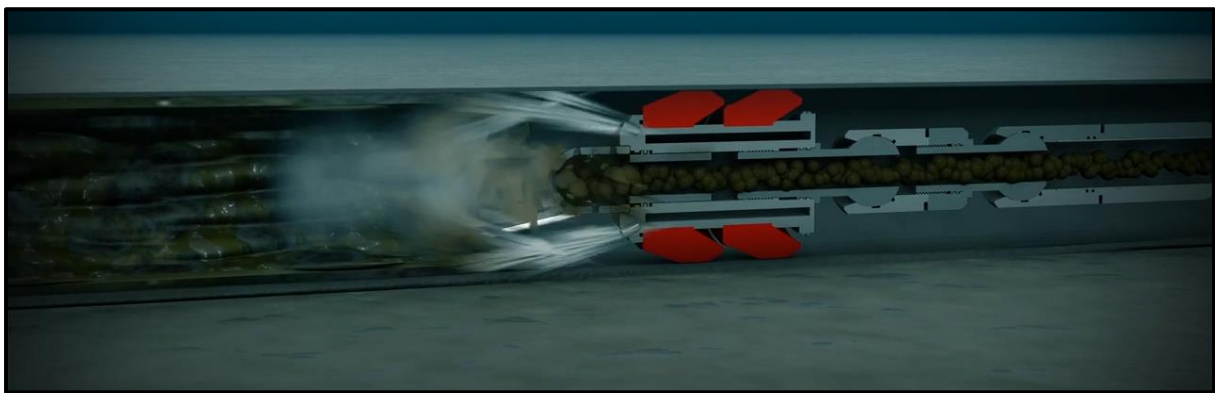

Figure 2. Coiled Tubing - Pipeline Blockage Removal [2]

Pipeline Blockage Remediation– External Intervention

If the less invasive blockage removal methods are unable to remove the blockage then a more invasive remedy may be required, such as:

- 1) Locally injecting a blockage flushing product (treated water / solvents / glycol / diesel) via small bore hot taps
- 2) Isolating the pipeline upstream and downstream of the blockage then cutting out, removing and replacing the entire blocked section
- 3) Replacing the pipeline or pipeline section

Blockage Removal - Local Injection and Flushing

Small bore hot taps allow local injection of blockage flushing product - midway, upstream and downstream of the blockage

STATS patented lightweight subsea hot tap strap clamp

- ❖ Fully pressure rated to pipeline design pressure (25yr design life)
- ❖ High pressure sealing with lightweight construction
- ❖ Easily re-configured for a range of pipe sizes by simple change-out of components.
- ❖ Both seals fully tested prior to breaking containment
- ❖ Double piston effect design enhances sealing when pipeline pressure is applied to the clamp
- ❖ Easily installed by diver or modified for ROV installation
- ❖ Can be installed over live pin-hole leak, if required
- ❖ Suitable for a wide range of pipe sizes

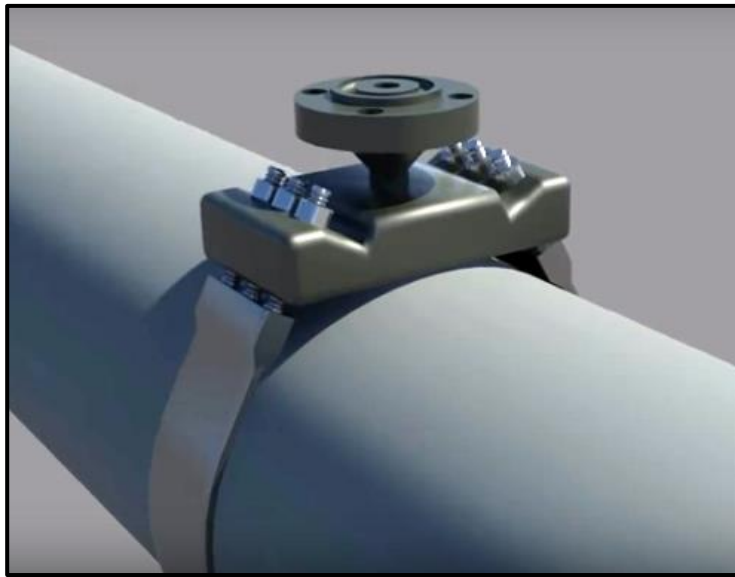

Figure 3. Lightweight Hot Tap - Strap Clamp

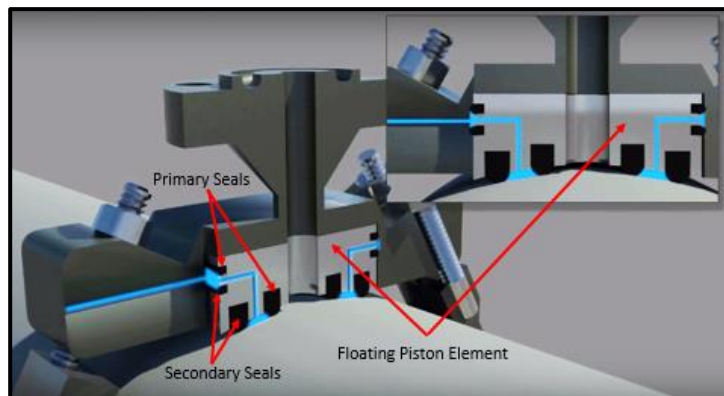

Figure 4. Secondary Seal – Leak off test

Pressurising and locking in the annulus test pressure and monitoring for pressure decay proves Secondary Seal

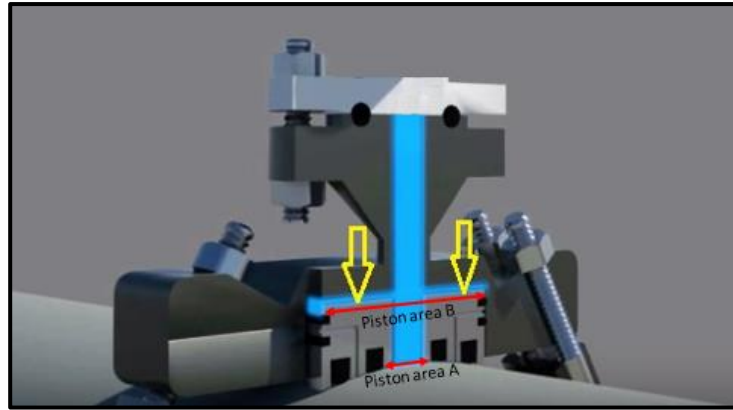

Figure 5. Primary Seal – Pressure Build Up Test

Pressurising the clamp body and monitoring the annulus for pressure build-up proves the Primary seal in the correct direction

Double Piston Effect - Sealing Enhancement

Due to the difference between piston areas A and B. Piston effect on the floating seal cartridge increases the sealing efficiency of the clamp to pipeline seals

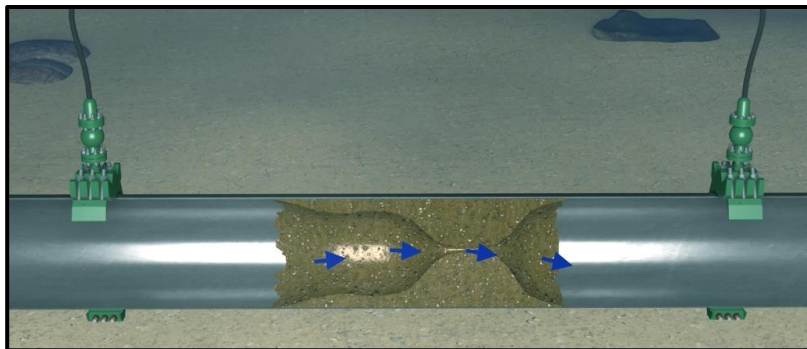

Figure 6. Small bore hot taps allow injection and venting

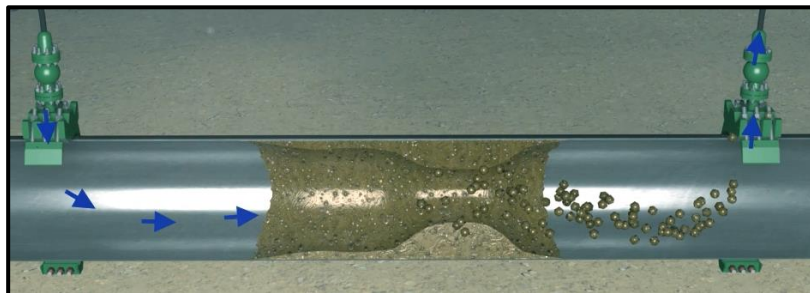

Figure 7. Flushing dissociates the blockage

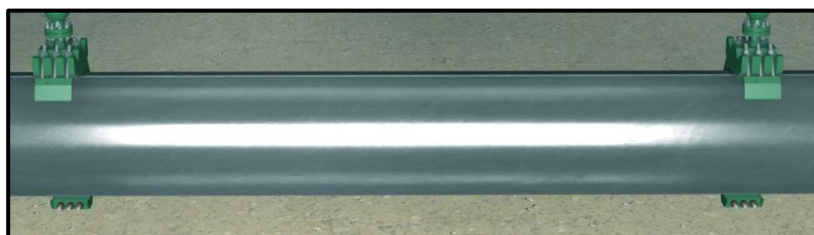

Figure 8. Blockage removed

Major Intervention – Section Replacement

This method relies on double block and bleed isolation tools as the entire blockage removal process can be done while the pipeline is pressurised, and if a bypass is installed, while production continues. As a blocked pipeline will have difficulties pigging isolation tools to either side of the blockage, the most appropriate method of isolation is to use isolation tools that are deployed through a hot tap penetration. This can be achieved with the BISEP® double block and bleed (DNVGL Type Approved) pipeline isolation tool.

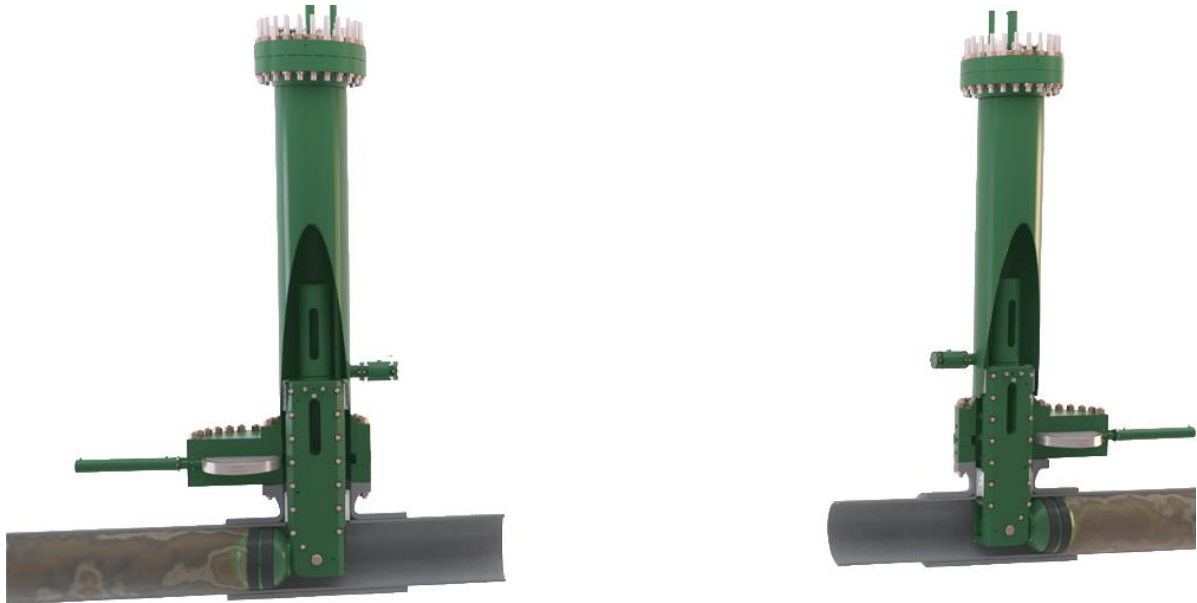

Figure 9. Dual BISEP Isolation – Blockage removed

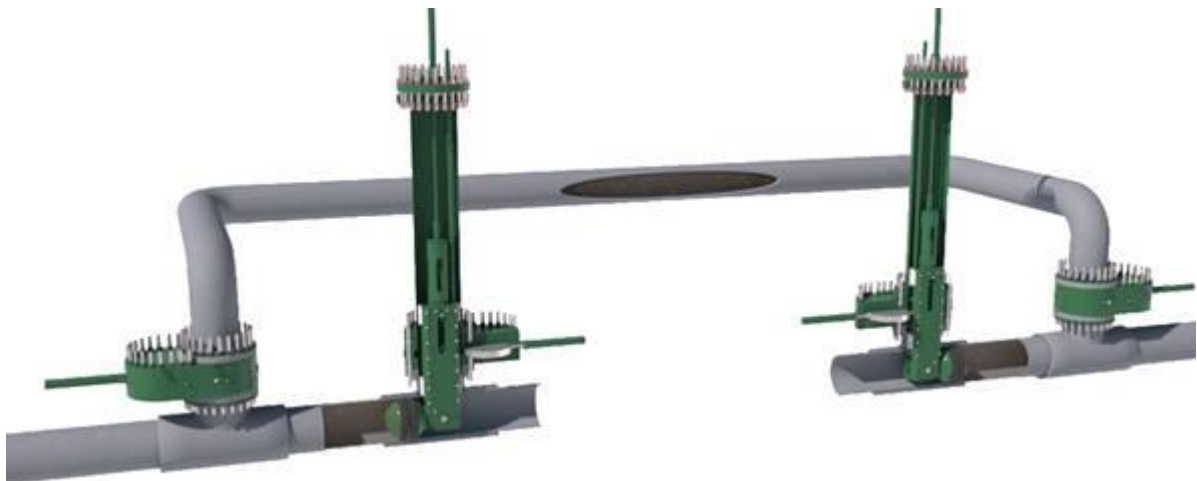

Figure 10. Bypass maintains production while blockage is being removed

BISEP Description

The BISEP (Branch Installed Self-Energised Plug) is comprised of a spherical sealing head, clevis arm retention, and pressure competent launcher. The tool is hydraulically operated with fail-safe actuation (self-energisation) via the pipeline pressure differential.

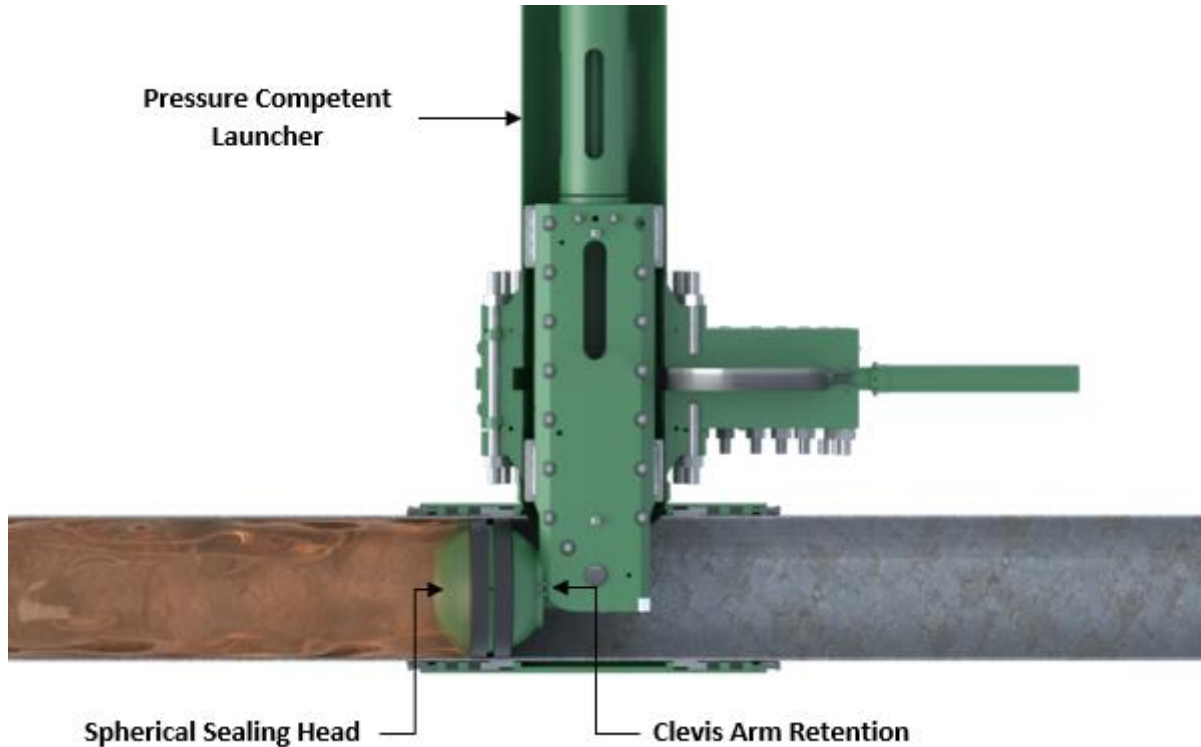

Figure 11. BISEP - key features

The BISEP arrives on-site inside the pressure competent launcher tube. The launcher tube facilitates testing of the sealing head integrity prior to deployment. One end of the launcher has a modified blind with two sealed penetrations. The first penetration is for the main deployment cylinder which pushes the spherical head into the pipe. The second penetration is a stem bar which houses the hydraulic connections for the sealing head. The movement of the stem bar into the launcher provides positive position indication for the deployment. This launcher is connected to the hot tap valve and pressure tested. STATS standard procedure is to pressure test this assembly against the closed valve with inert fluid (water or Nitrogen).

Inside the launcher tube is the sealing head and clevis arm assembly. The deployment cylinder on the launcher drives the spherical head through the hot tap penetration into the pipe where it is rotated 90 degrees, towards the pressure threat, in the opposing direction to the worksite.



Figure 12. BISEP Set Sequence

The rotation of the sealing head is performed hydraulically to ensure full control. The spherical shape of the head ensures that it can rotate freely inside the pipe. Head rotation orientates the reaction shoulder against the clevis arms.

Once the head is fully rotated, the seals are activated. Initial activation is provided by the internally mounted hydraulic cylinder. This axially compresses the two seals, whose resultant radial expansion causes them to compress against the pipe wall, creating a seal.

The boundary, once established, offers dual leak tight barriers. The annulus between the seals can be pressurised or depressurised to test the seals. The testing of the dual seals is performed in the isolating direction which requires the isolated section to be vented to ambient. Thus, on a mid-line isolation, both BISEPs at either end of the isolation are installed and set prior to the isolation being verified. This pressure venting can be performed using the BISEP launcher vent ports as the BISEP hot tap penetrations are in the isolated zone.

Double Block Verification

Once the isolated section is vented, the BISEP has full pressure differential across it. The annulus between the seals will be slightly above the pipeline pressure due to the seal compression reducing the volume of this void. This annulus void is piped through the launcher to give external access which allows the pressure to be raised, if required, to ensure a suitable differential pressure can be locked in for the secondary seal test. Holding the annulus above the pipeline pressure ensures no fluid can pass from the pipeline to the annulus during the secondary seal test.

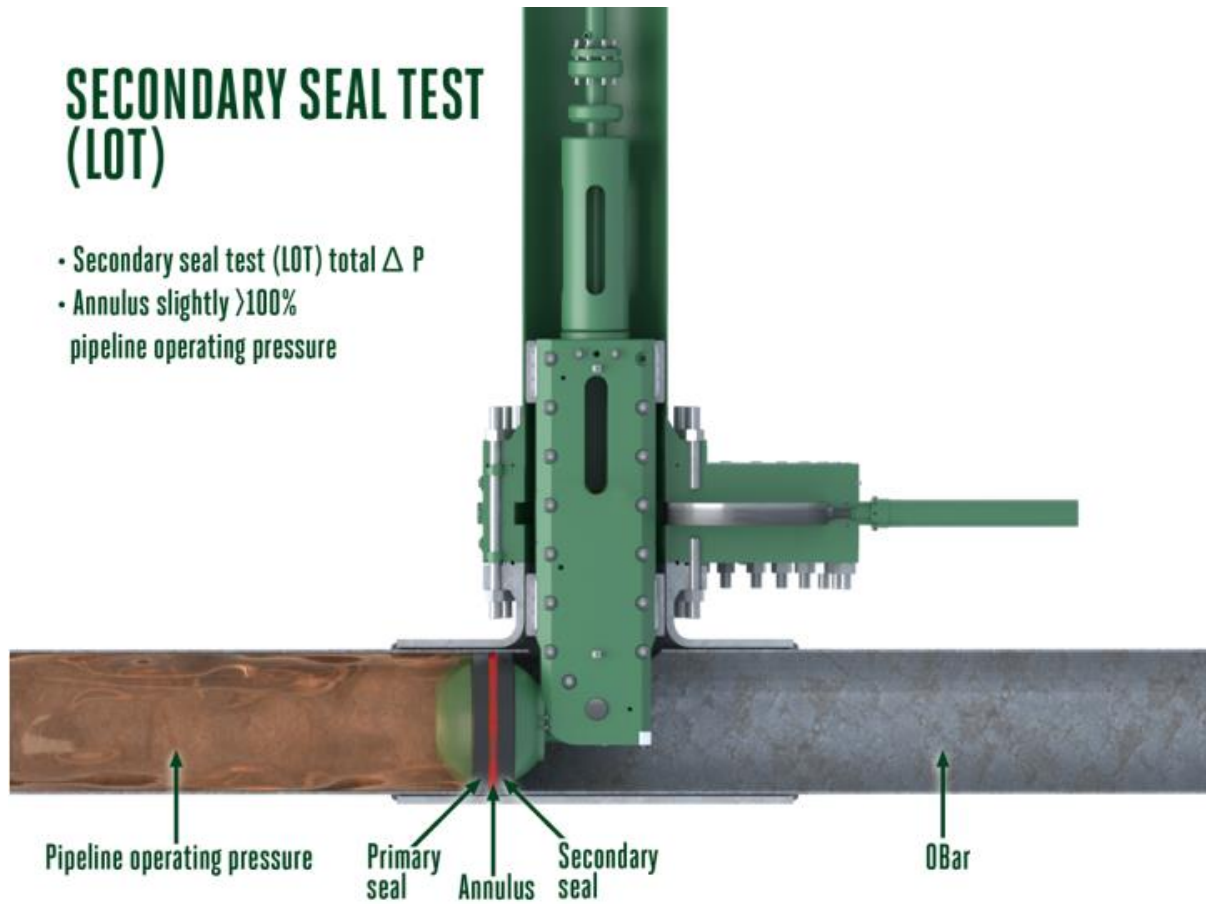

Figure 13. BISEP annulus test

With pressure locked in the annulus and the pressure behind the BISEP vented to ambient, the BISEP secondary seal is holding full pipeline pressure in the isolated direction. This condition is locked in to prove the secondary seal.

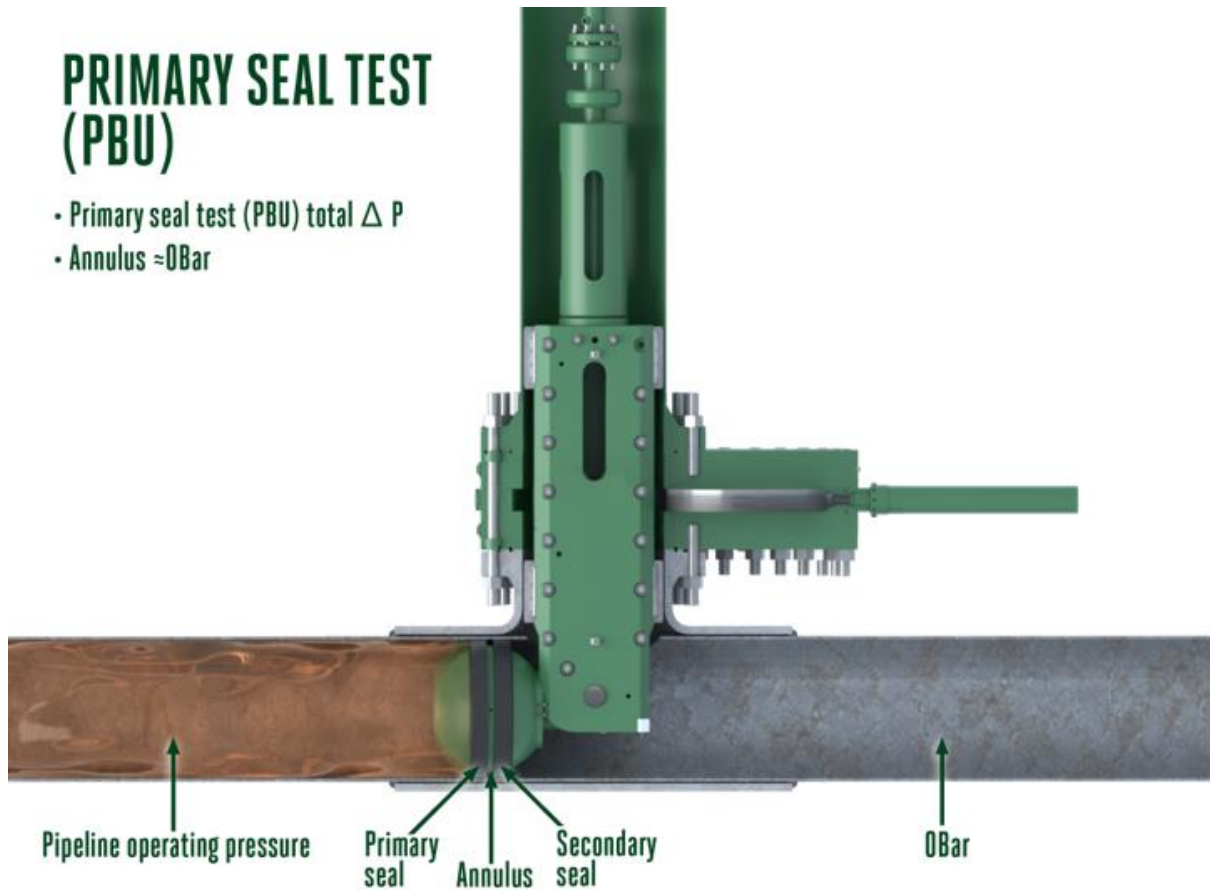

Figure 14. BISEP double block verification

Once the secondary seal has been verified, the annulus between the seals is vented to ambient using the external piped connection. The vented annulus is then locked in and monitored for pressure rise. At this time the full pipeline pressure is held by the primary seal proving the BISEP primary seal in the isolated direction. Once tests are complete, the annulus is left locked in and monitored for the duration of the isolation.

Self-Energisation

A vital safety feature of the BISEP is self-energisation, where the differential pressure across the BISEP head generated by the isolated pipeline pressure retains the seal activation independent of the hydraulics.

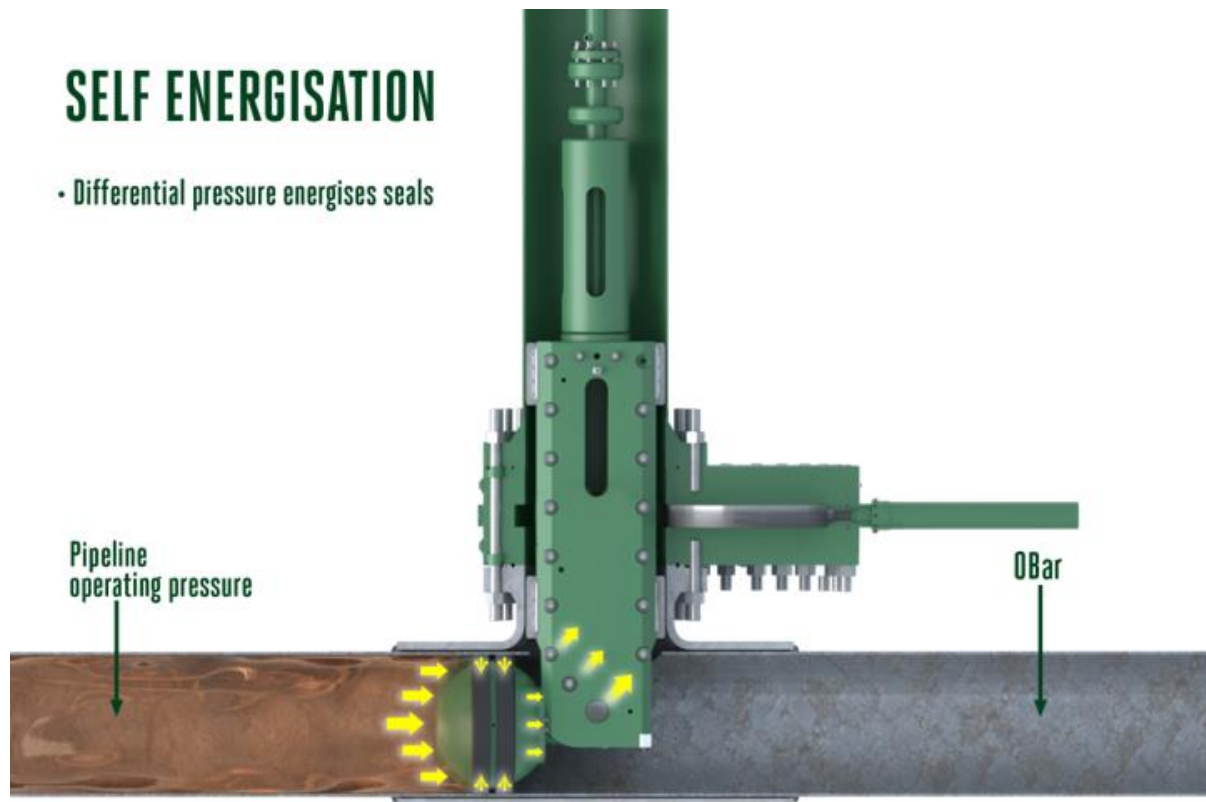

Figure 15. BISEP Self-Energisation

The axial movement of the pressure head is retained by the seal and, once fully constrained by the pipe bore, the compression seal generates a contact pressure and can be assessed as a fluid for load calculations.

The pipeline pressure acts on the whole pressure head, generating an axial force towards the seal. An axial load balance across the head shows that the rubber pressure multiplied by the radial cross sectional area of the seal contact with the head must equal the load generated by the pipeline pressure. The annular nature of the seal ensures that the seal contact area is significantly less than the disc area of the head so the rubber pressure in the seal is held above that of the pipeline pressure. This has two benefits. Firstly, the pipeline pressure can't pass a seal at higher pressure and secondly this high rubber pressure is highly compliant to pitting, seam welds and poor pipe bore condition. The self-energisation pressure from the pipeline pressure must be sufficient to overcome the initial load to compress the seal out to the pipe wall. This load is defined as the self-energisation pressure, which is the minimum differential pressure across the tool which will maintain the seal in the case of total loss of hydraulic pressure and normally in the region of 10 bar (150 psi).

This axial load then acts on the annulus ring which in turn is retained axially by the secondary seal. Therefore, the secondary seal is pressurised by the differential across the sealing head in a similar manner to the primary seal. The secondary seal is retained by the seal support head which is a leak tight head equivalent to the pressure head. This seal support head bears on two solid clevis arms, each one capable of taking the full load. The clevis arms are axially retained by the hot tap penetration and fitting.

The assessment above is simplified and does not take account of the hydraulic actuation load which is additional to the differential pressure load. This hydraulic set load is retained and monitored during the isolation to ensure that a loss of pipeline pressure would not result in a loss of either barrier.

Isolation Monitoring

During the period of isolation the following circuits can be monitored:

- Annulus between the seals
- Hydraulic set
- Hydraulic unset (normally vented)
- Body vent – this is the cavity inside the core of the spherical head.

Any change in the status of the isolation would cause a change in these circuits which would provide sufficient warning to either address the change or clear the worksite. The connection to the annulus does provide the ability to vent any rise in annulus pressure in a similar manner to a double block and bleed valve. In addition to this there is the ability to raise the hydraulic set pressure if required to improve the seal or reduce the hydraulic pressure to reduce the load on the seal.

Sour Service

The BISEP is designed to be compliant with NACE for sour service when fitted with HNBR seals. However, during the isolation, the clevis arms and associated equipment are in the isolated zone which will be flushed / purged of sour hydrocarbons during the isolation to protect the worksite, therefore the exposure to sour fluid will be minimal. Since the BISEP head is deployed outboard of the hot tap penetration, the launchers can be used for access to vent / flush / drain / purge the isolated section. The launchers can also be used to de-air and refill the isolated section after the workscope is complete.



Figure 16. BISEP isolating pipeline on-site with dead leg cut away

Pressure Testing

The BISEP is designed to resist back pressure so can be used as a test boundary for the reinstatement test. This back pressure is however limited, as the pressure must be retained by the hydraulic set pressure. The BISEP is designed to take 50% of the design pressure as a reverse pressure differential. This is a differential pressure and allows a test pressure 50% higher than the isolated pipeline pressure to be applied to the repaired pipe spool as a pressure test prior to removing the BISEP isolation.

Blockage Removal – Section Replacement Methodology

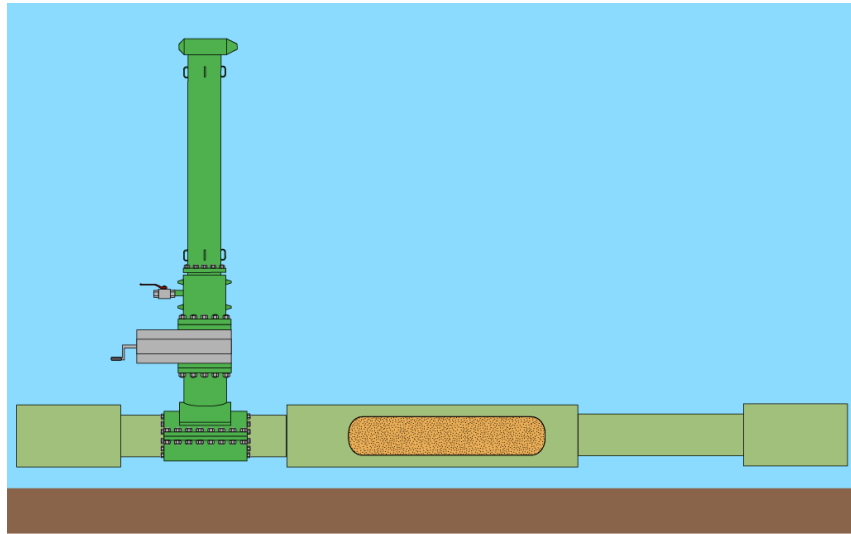

Figure 17. Hot Tap Clamp installed, deployed c/w Slab Valve and Hot Tap machine

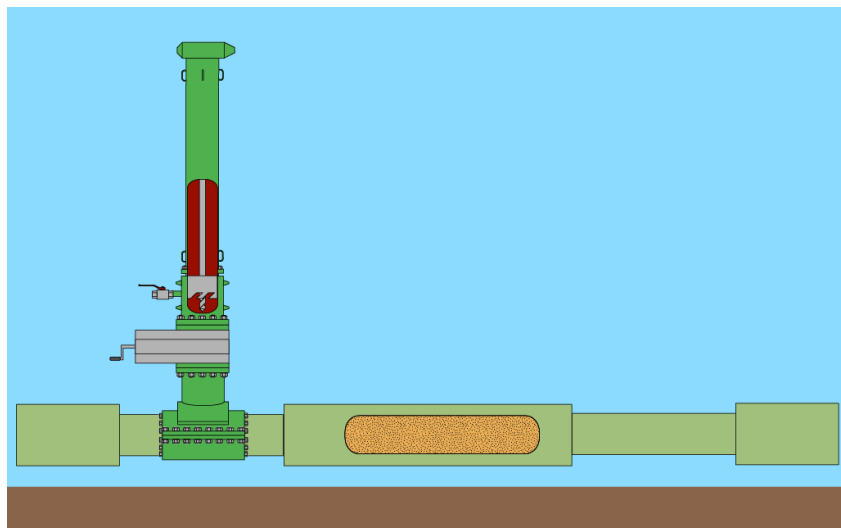
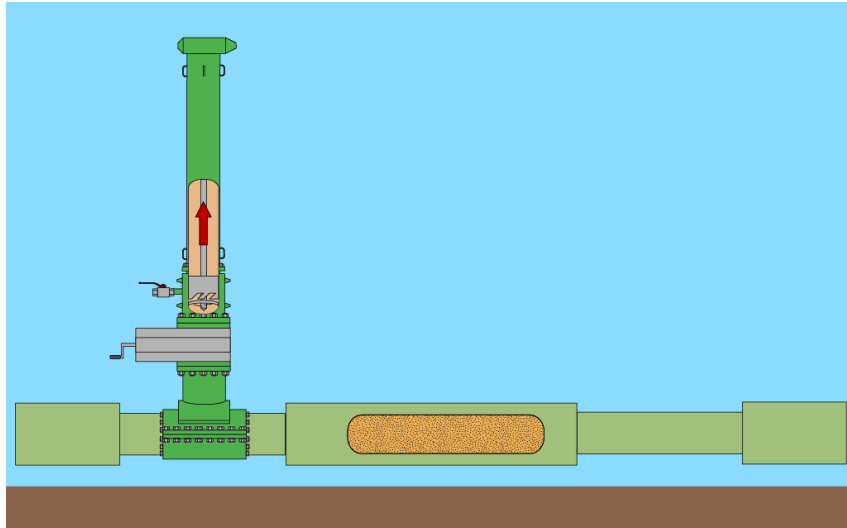
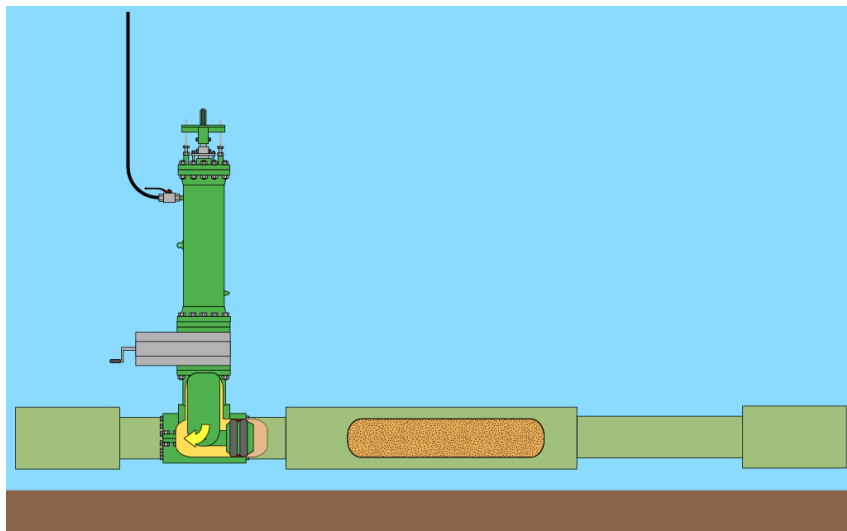

Figure 18. Joints Leak tested and hot tap completed



**Figure 19. Recover coupon into hot tap unit and close slab valve
Remove hot tap machine, deploy and install BISEP launcher
Leak test joints, Open slab valve**



**Figure 20. Deploy BISEP, set and test seals.
Inject flushing medium to confirm unrestricted flow through upstream pipeline
section**

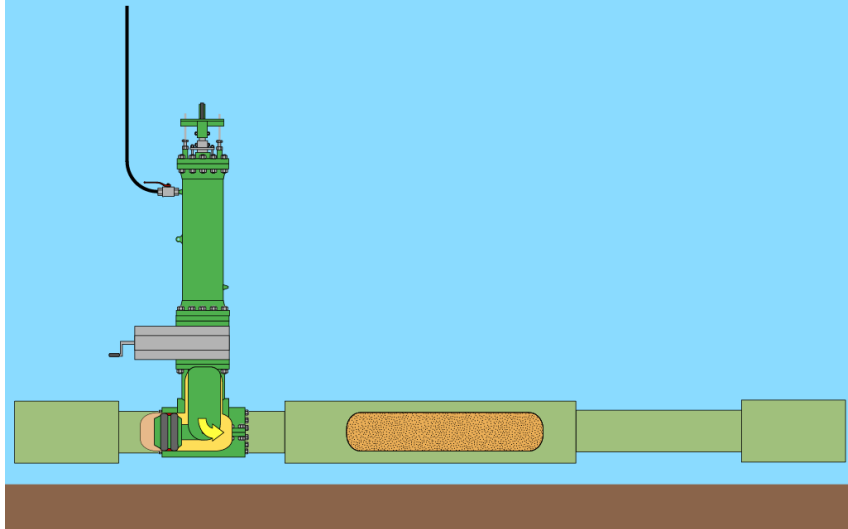

**Figure 21. Unset, rotate (180 degrees) and redeploy BISEP
Test BISEP seals
Inject to attempt blockage removal**

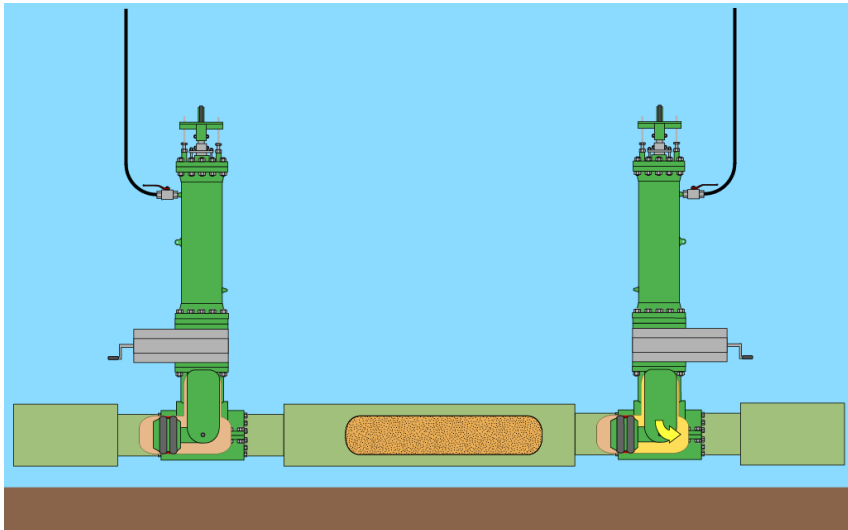

**Figure 22. If blockage removal is unsuccessful, install downstream BISEP
Confirm unrestricted flow through downstream pipeline section**

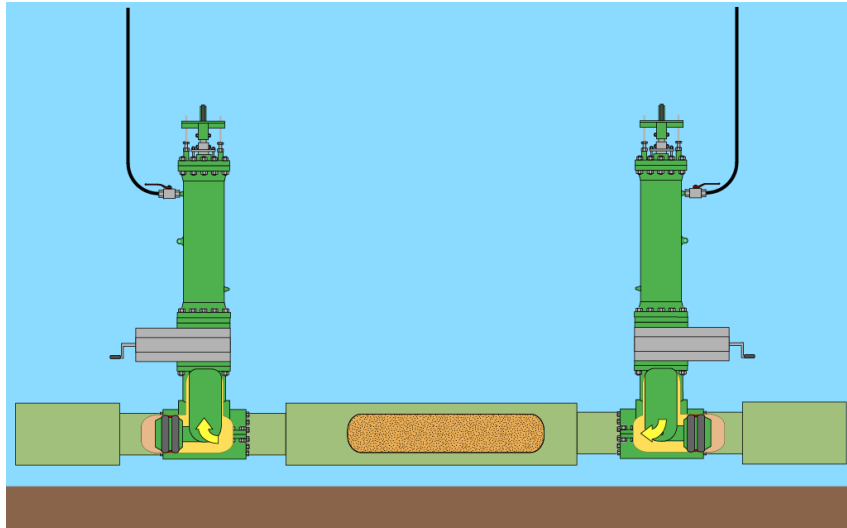

**Figure 23. Unset, rotate (180 degrees) and redeploy BISEP
Prove Double Block Isolation of both BISEPs
Inject to attempt blockage removal**

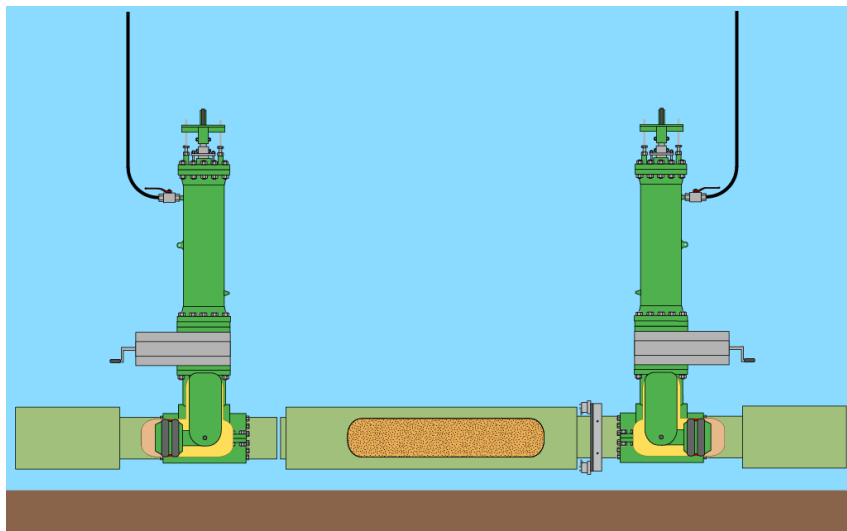

Figure 24. Proceed with cutting the block section of pipeline

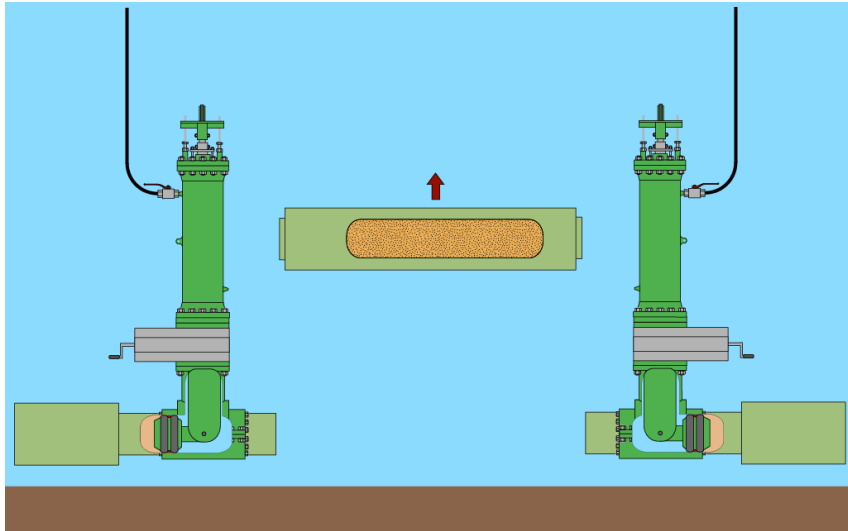

Figure 25. Remove blocked section



**Figure 26. Replace pipeline section
Leak test new connections against rear of BISEPS**



Figure 27. Remove both BISEPS



Figure 28. prepare to install completion plugs with the hot tap machine



Figure 29. Install completion plugs

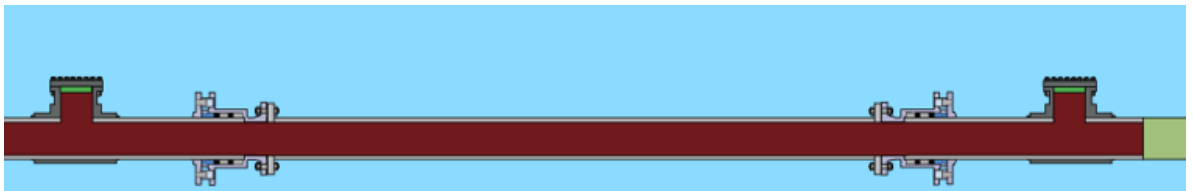

Figure 30. Remove slab valves and install permanent blinds

Reference

[1] London Centre for Nanotechnology, (2001), Blocked Pipe [ONLINE]. Available at: <https://www.london-nano.com/research/asphaltene-aggregation-presence-laponite-clay>.

[2] Blue Fin Group, (2019), Coiled Tubing - Pipeline Blockage Removal [ONLINE]. Available at: <https://www.bluefingrp.com>.